

KARE

DESIGN

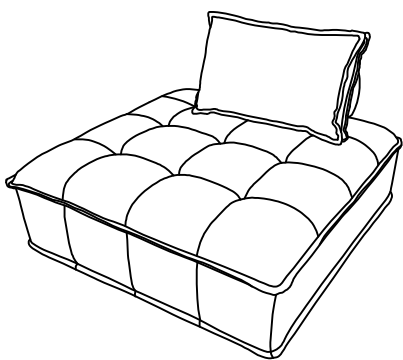

29005
(PORTOFINO)

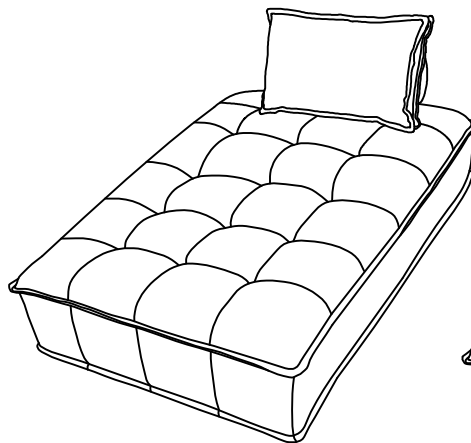

29016
(PORTOFINO
ELEMENT L)

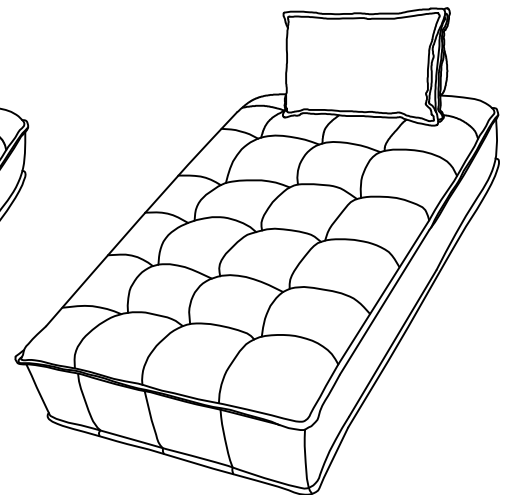

71363
(RECAMIERE
PORTOFINO
YELLOW 183cm)

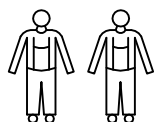

**Below is shown assembly of module: 29005 (PORTOFINO)
It is exactly the same for modules: 29016 (PORTOFINO ELEMENT L),
71363 (RECAMIERE PORTOFINO YELLOW 183cm)**

1.

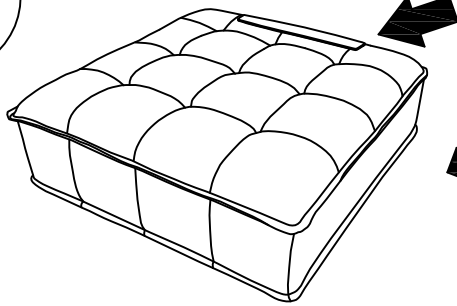

**Unfasten the
Velcro strap**

ROTATE



**Turn the module
on any of the
sides.**



2.

**Take out the
backrest pillow
and the backrest
support**

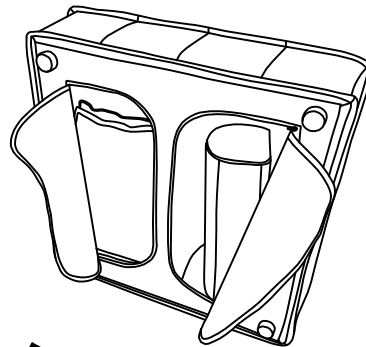

3.

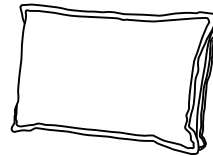
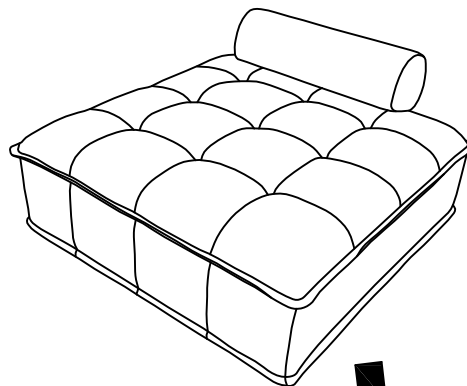

**Mount the backrest
support by using
the Velcro straps
and place the
backrest pillow**



4.

