

39200 Pendant Lamp Dusty Bell Gold Big
39201 Hanging Lamp Dusty Bell Blau 48CM

KARE
DESIGN

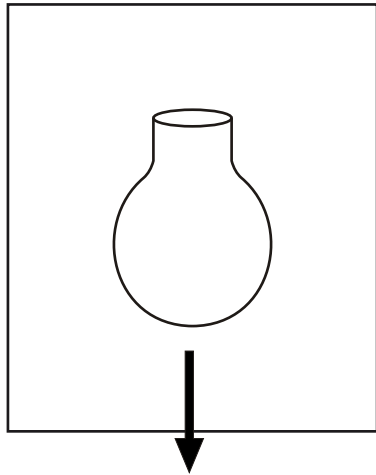

Glass Drop

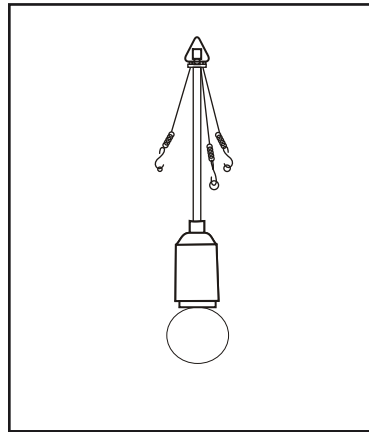

Holder with pipe and 3 S Hook

Step-01

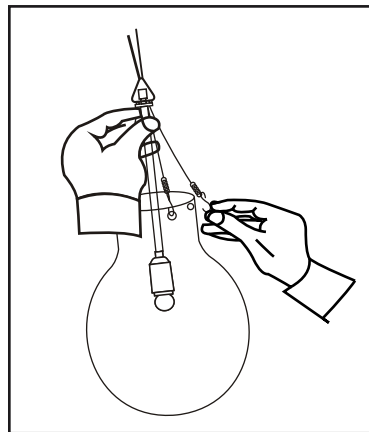
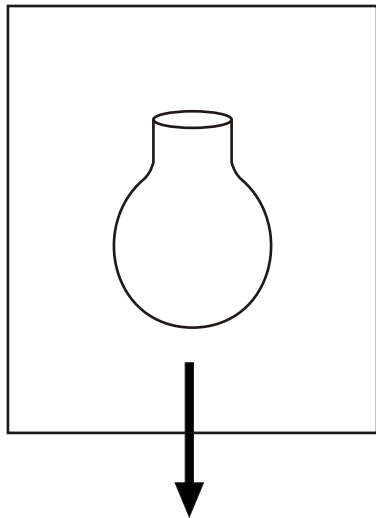

Step-02

Hold Glass drop by hand and Insert S hook in top 03 hole one by one in the glass shown as picture step -02

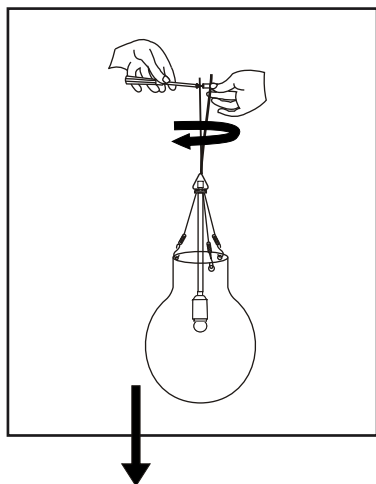

For straight alignment of Holder use screw driver for tightened steel cord and loose febric cord.

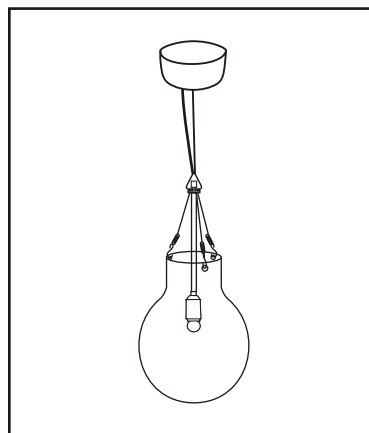

Assemble Picture of Drop

Step-03

39200 Pendant Lamp Dusty Bell Gold Big

39201 Hanging Lamp Dusty Bell Blau 48CM

KARE
DESIGN

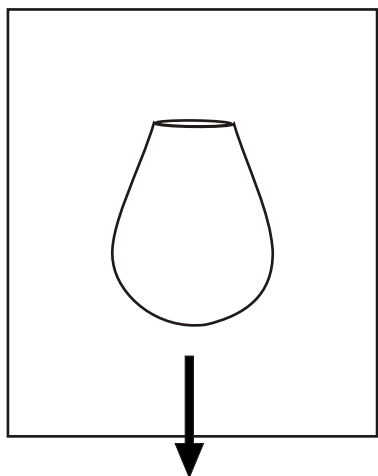

Glass Drop

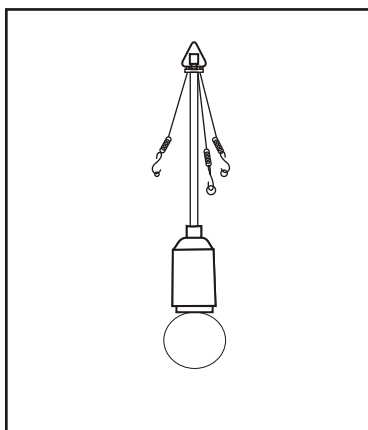

Holder with pipe and 3 S Hook

Step-01

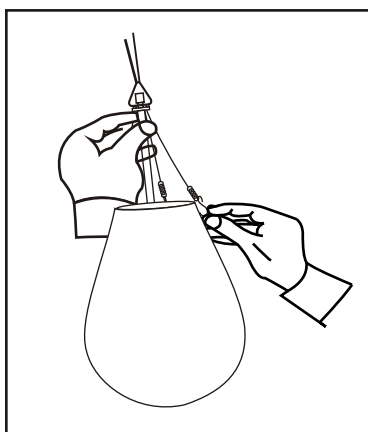
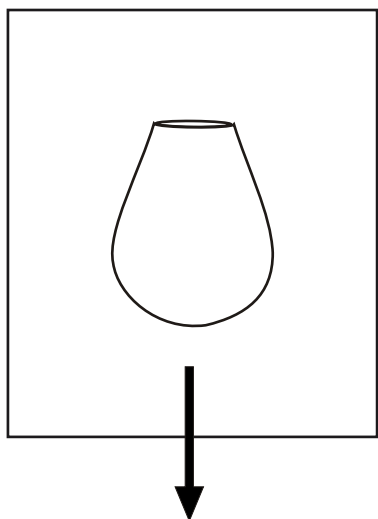

Step-02

Hold Glass drop by hand and Insert S hook in top 03 hole one by one in the glass shown as picture step -02

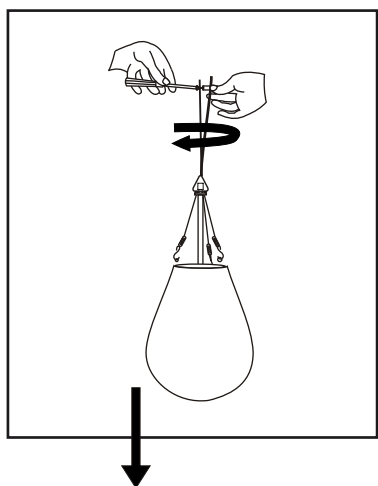

For straight alignment of Holder use screw driver for tightened steel cord and loose fabric cord.

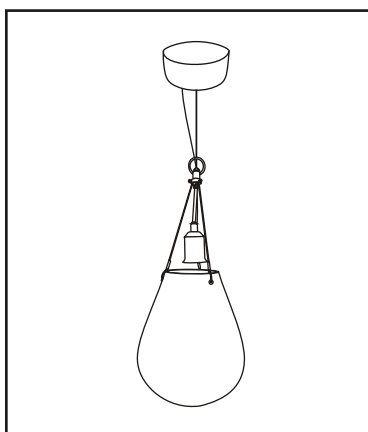

Assemble Picture of Drop

Step-03

39200 Pendant Lamp Dusty Bell Gold Big
39201 Hanging Lamp Dusty Bell Blau 48CM

KARE
DESIGN

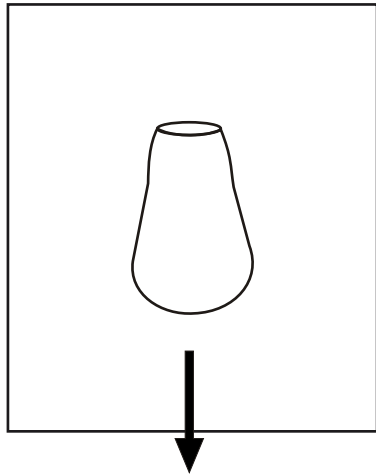

Glass Drop

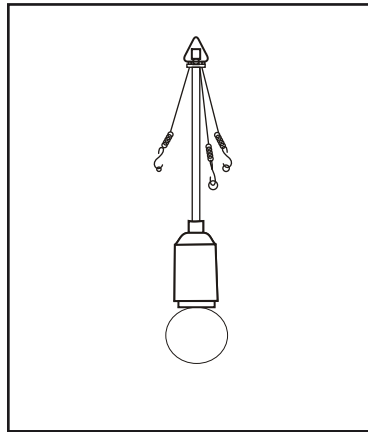

Holder with pipe and 3 S Hook

Step-01

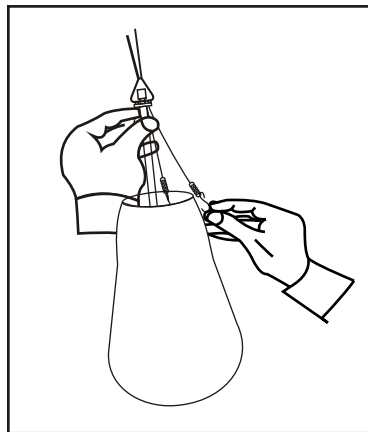
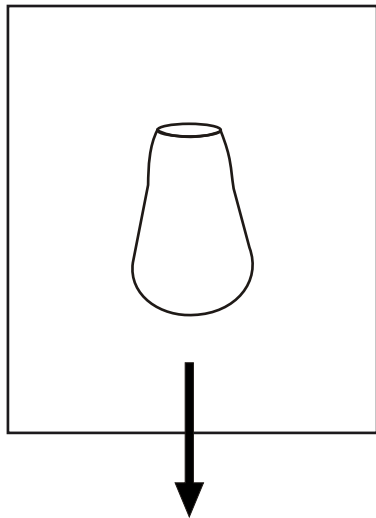

Step-02

Hold Glass drop by hand and Insert S hook in top 03 hole one by one in the glass shown as picture step -02

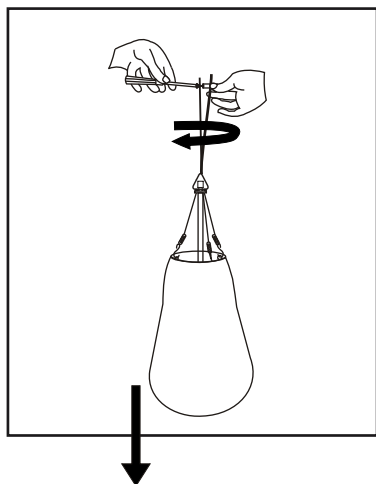

For straight alignment
of Holder use screw driver
for tightened steel cord
and loose fabric cord.

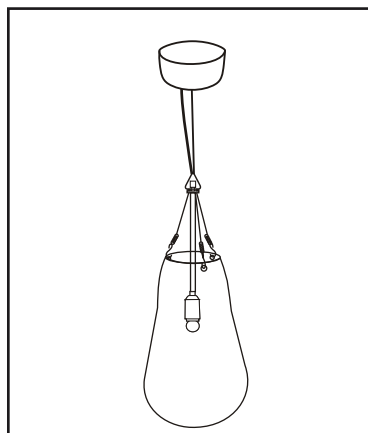



Assemble Picture of Drop

Step-03

39200 Pendant Lamp Dusty Bell Gold Big
39201 Hanging Lamp Dusty Bell Blau 48CM

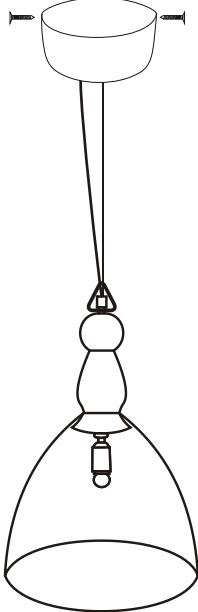

ITEM	PARTS INCLUDED	DESCRIPTIN
(A)		HANGING BAR
(B)		SCREW
(C)		MOUNTING SCREW
(D)		LAMP SHADE

Mounting Assembly Instructions

