

KARE

DESIGN



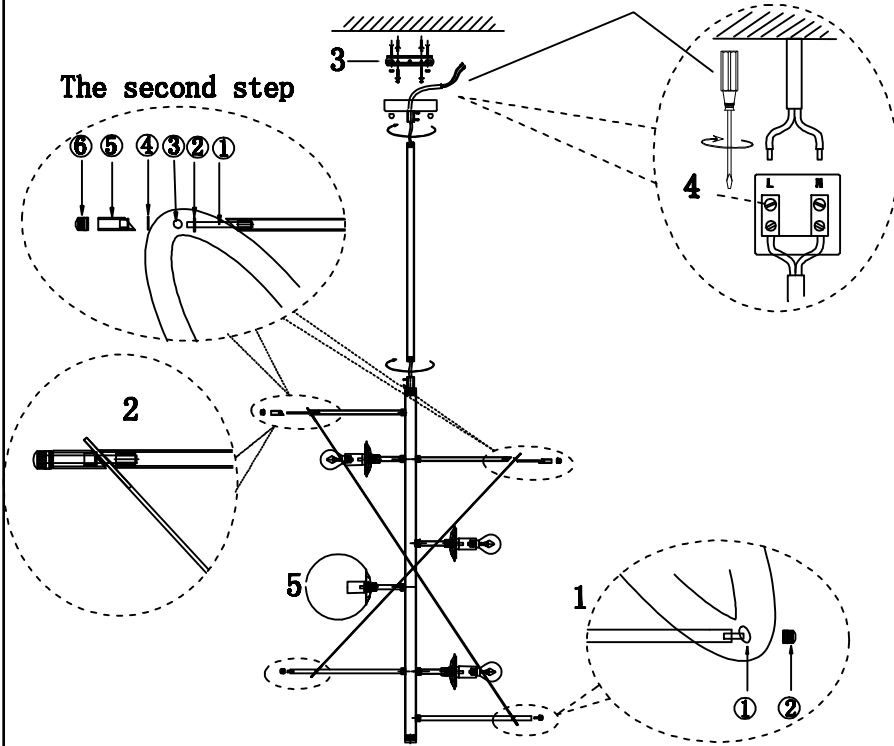

#53751. Hanging Lamp Planets

not included

The second step



The first step
First, the bottom up

			
1PCS	1PCS	8PCS	NOT INCLUDED

The third step

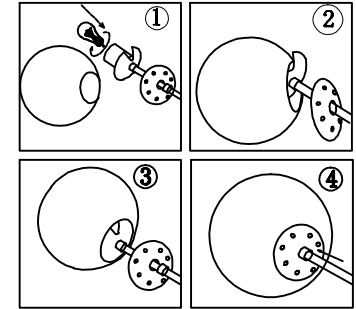
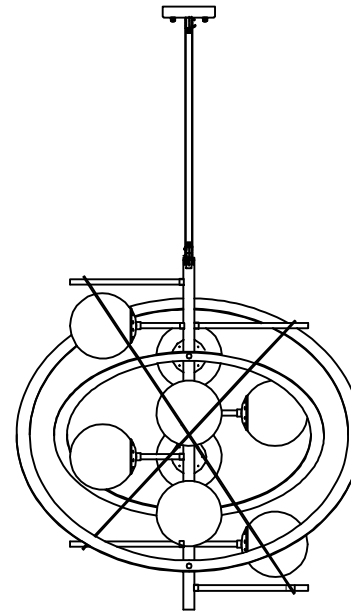

Please follow the order
Go from small to large circles
(1) $\phi 610$ \rightarrow (2) $\phi 700$ \rightarrow (3) $\phi 780$ \rightarrow (4) $\phi 870$

