

A*1

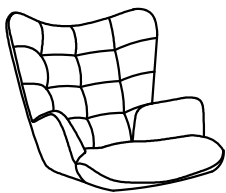

B*1

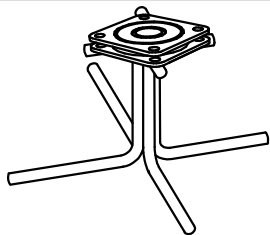

C*2



M6x45

D*2



M6x25

E*1



1

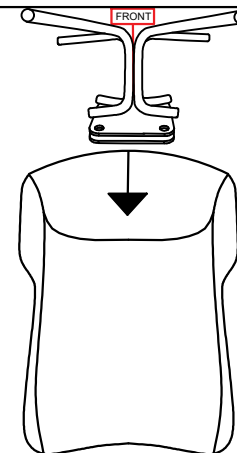

2

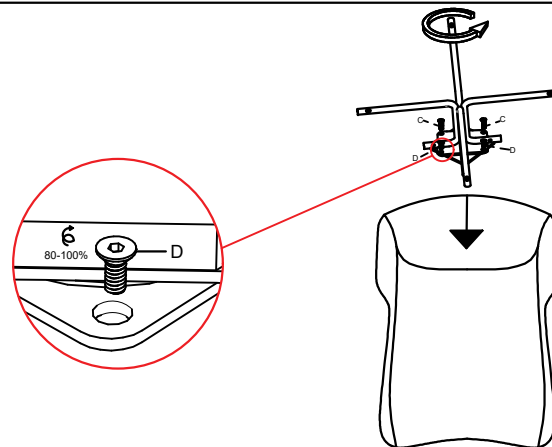

3

