

ASSEMBLY INSTRUCTIONS

Sheet No:1 of 11

KARE
DESIGN

PRODUCT NAME: 71419 – Lowboard Linnea 160x45cm

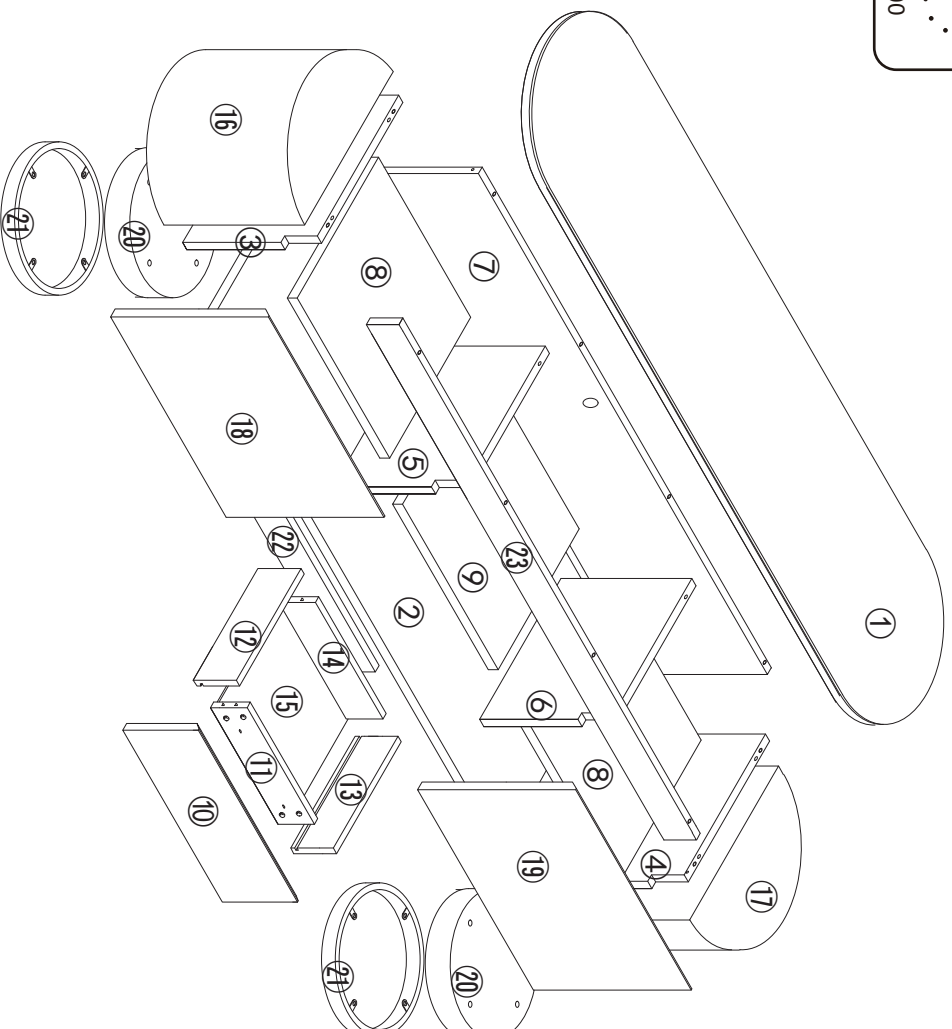
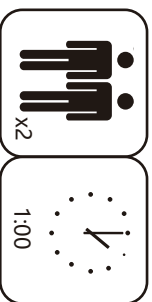

PART LIST

PART	DSSC	QTY	BOX NO.
①	TOP PANEL	1	1/2
②	BOTTOM PANEL	1	1/2
③	RHS PANEL	1	1/2
④	LHS PANEL	1	1/2
⑤	RHS MIDDLE SUPPORT PANEL	1	1/2
⑥	LHS MIDDLE SUPPORT PANEL	1	1/2
⑦	BACK PANEL	1	1/2
⑧	SHELVE	2	1/2
⑨	MIDDLE SHELVE	1	1/2
⑩	DRAWER FACIA	1	2/2
⑪	FACIA BACK PANEL	1	1/2
⑫	DRAWER RHS PANEL	1	1/2
⑬	DRAWER LHS PANEL	1	1/2
⑭	DRAWER BACK PANEL	1	1/2
⑮	DRAWER BOTTPM PANEL	1	1/2
⑯	RHS END PANEL	1	2/2
⑰	LHS END PANEL	1	2/2
⑱	RHS DOOR	1	2/2
⑲	LHS DOOR	1	2/2
⑳	BASE LEGS	2	1/2
㉑	BASE SUPPORT BOARD SUPPORT PANEL	2	1/2
㉒	BOARD SUPPORT PANEL	1	1/2
㉓	UNIT SUPPORT PANEL	1	1/2

ASSEMBLY INSTRUCTIONS







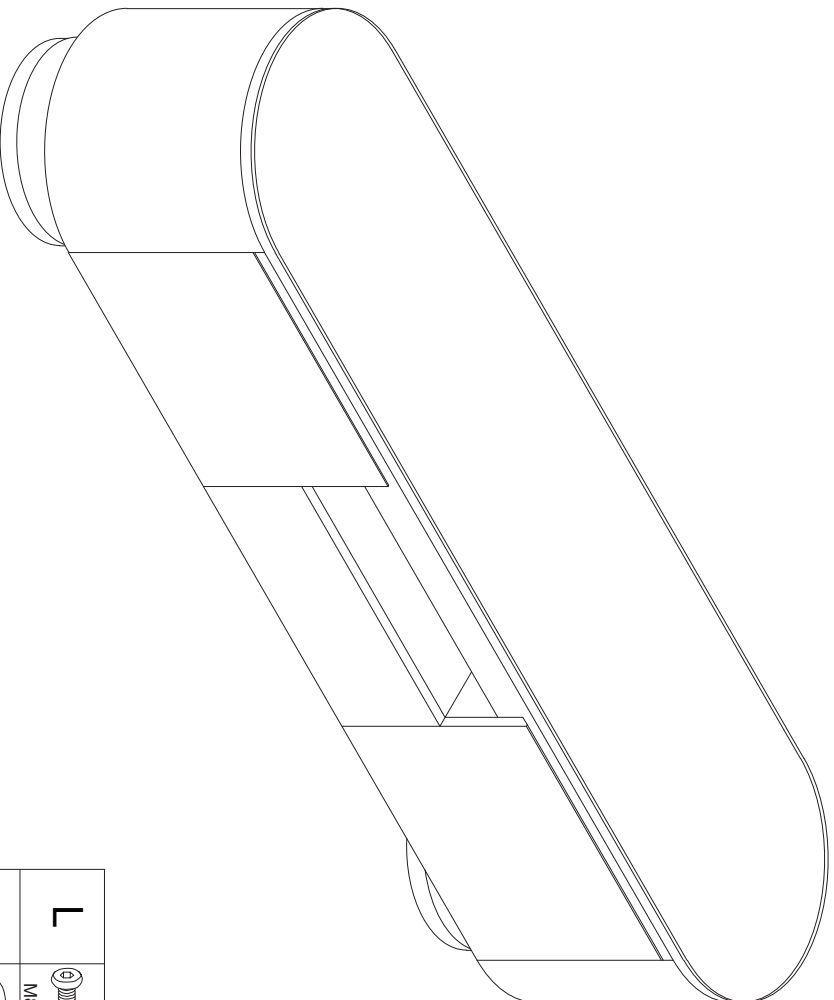







Sheet No:2 of 11

KAREN
DESIGN

PRODUCT NAME: 71419 – Lowboard Linnea 160x45cm



PART LIST

PART	DSSC.	DSSC	QTY	BOX NO.
A		Screw	46	1/2
B		Position pin	8	1/2
C		Nut	46	1/2
D		Tapping Screw	30	1/2
E		Slide	4	1/2
F		Slide	4	1/2
G		Support pin	8	1/2
H		Screw	4	1/2
I	 M6*25	Allen bolt	10	1/2
J		Allen Key	1	1/2
K	 M8*20	Allen bolt	8	1/2
L	 M8*50	Allen bolt	8	1/2
M	 M8*18	Flast washer	16	1/2
N		Hole cover	1	1/2
O		Masking cover	46	1/2

ASSEMBLY INSTRUCTIONS





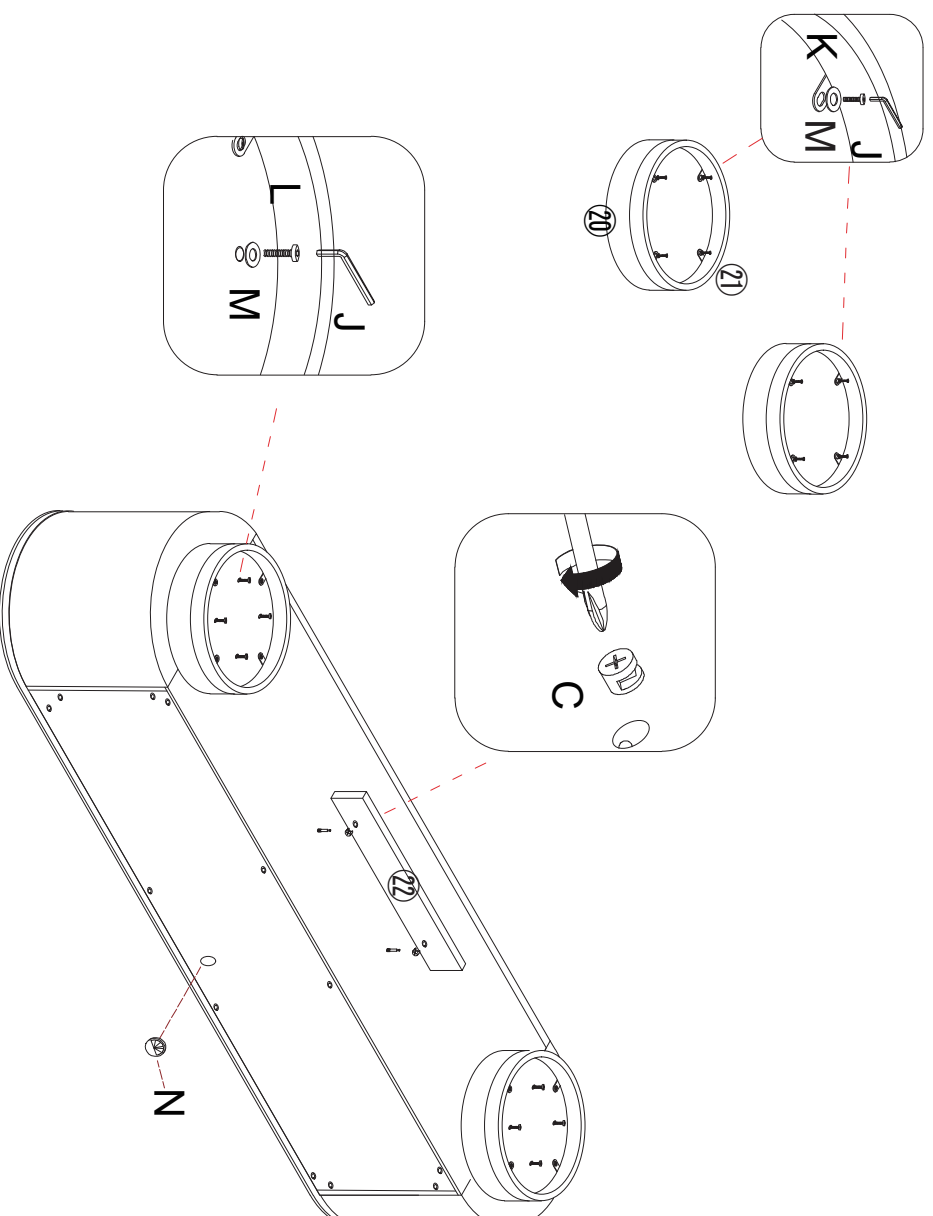

Sheet No:8 of 11

KARE
DESIGN

PRODUCT NAME: 71419 – Lowboard Linnea 160x45cm



PART LIST

PART	DSSC.	DSSC	QTY	BOX NO.
C		Nut	2	1/2
J		Allen bolt	1	1/2
K		Allen bolt	8	1/2
L		Allen bolt	8	1/2
M		Flange washer	16	1/2
N		Hole cover	1	1/2

ASSEMBLY INSTRUCTIONS

Sheet No: 11 of 11

PRODUCT NAME: 71419 – Lowboard Linnea 160x45cm

KARE
DESIGN

