

# KARE

DESIGN

# 82035

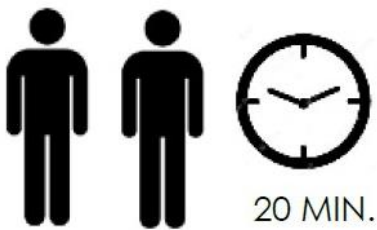
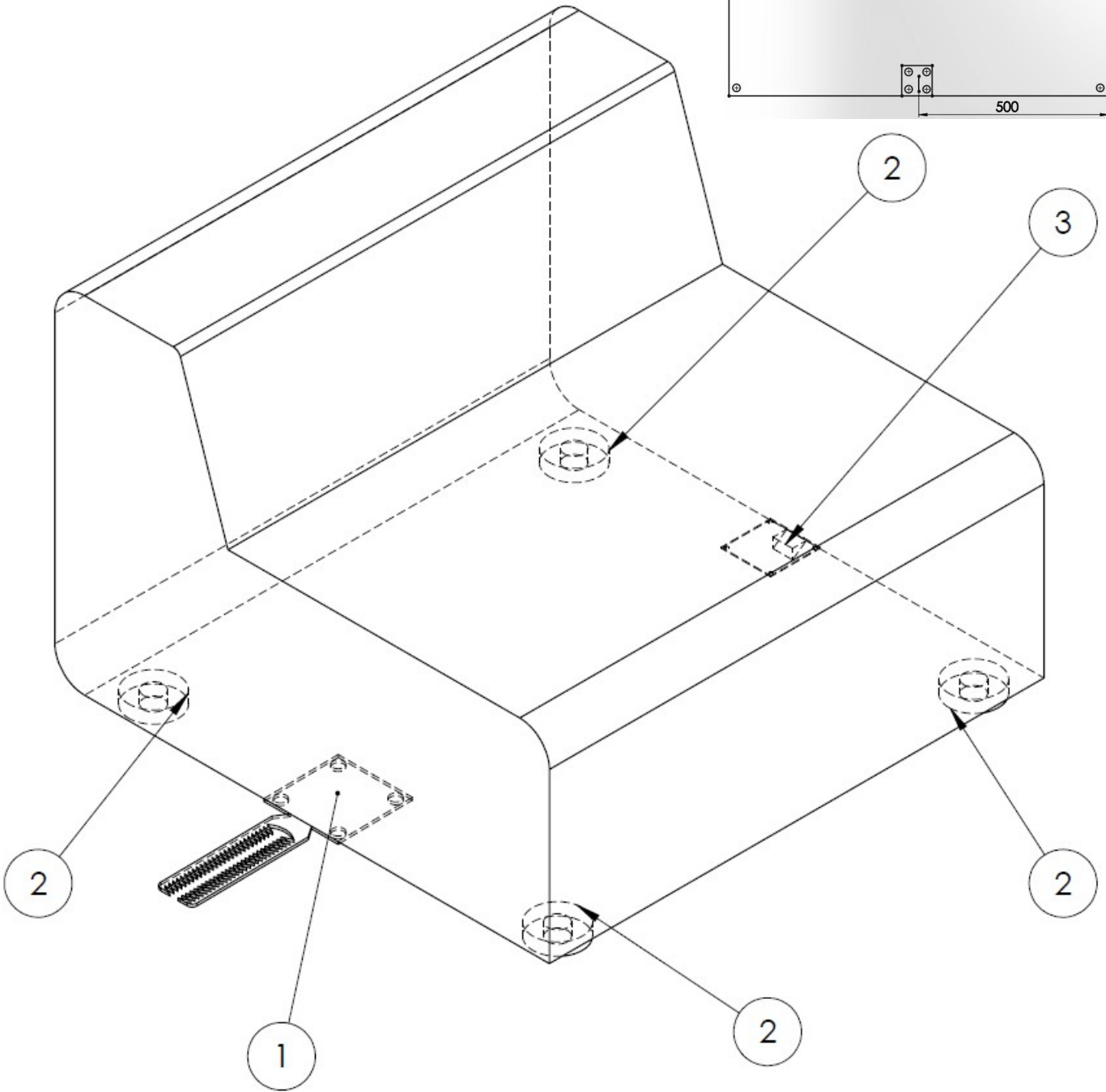
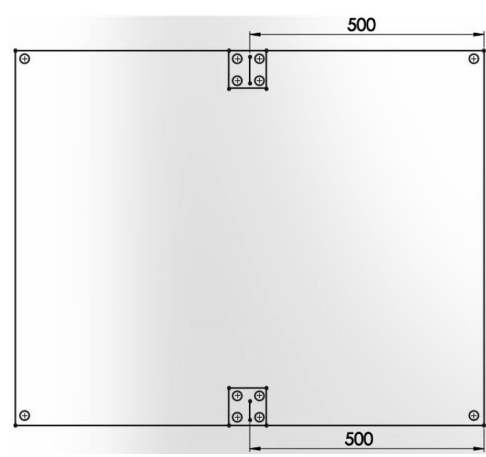

ITEM No.	ITEM	QUANTITY
1.		1
2.		4
3.		1