

# KARBE

## DESIGN

### ASSEMBLY INSTRUCTION

CODE NO --- 84452

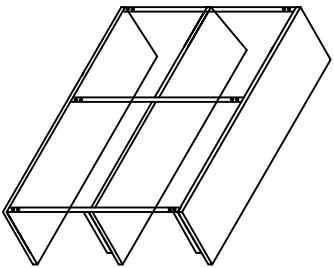

(A)



IRON FRAME - 3

(B)

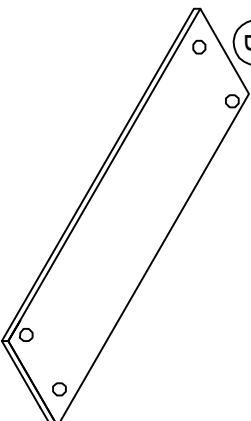

SHELF - 3

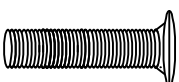

SCREW = 8



BOLT - 12

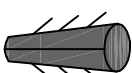

DOWEL - 6  
6 mm

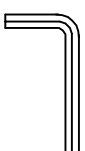

ELENKY - 1

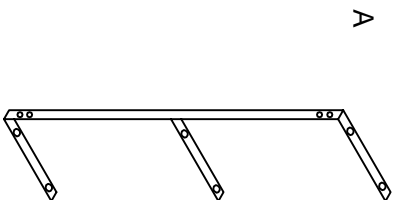

A

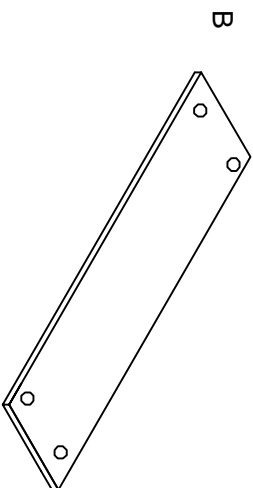

B

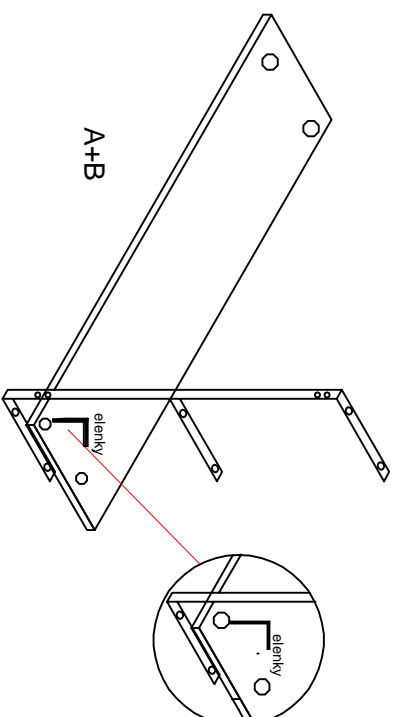

A+B