





ITEM NO.	PART NUMBER	QTY.
1		5
2		1
3		1



ITEM NO.	NAME	QTY.
1		1
2		4
3		1

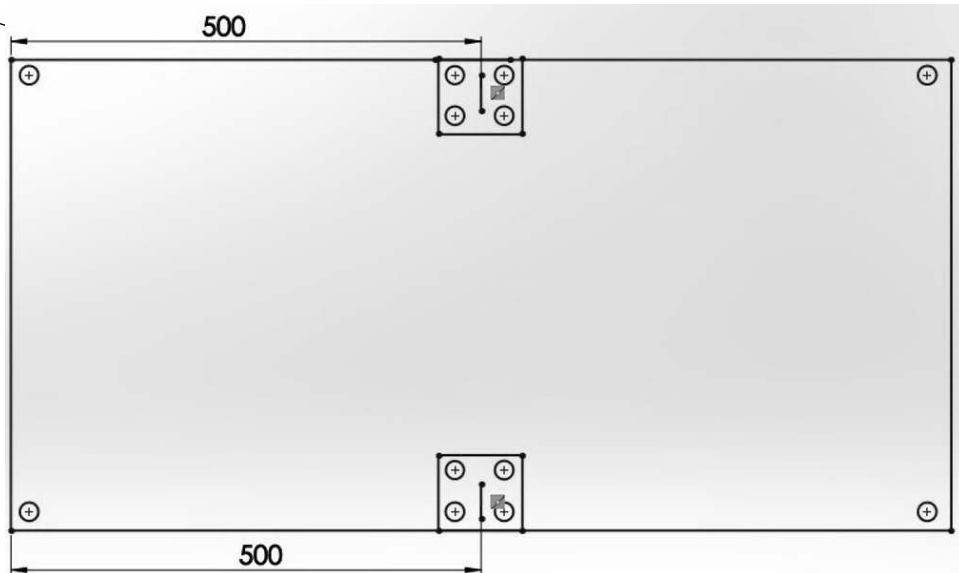
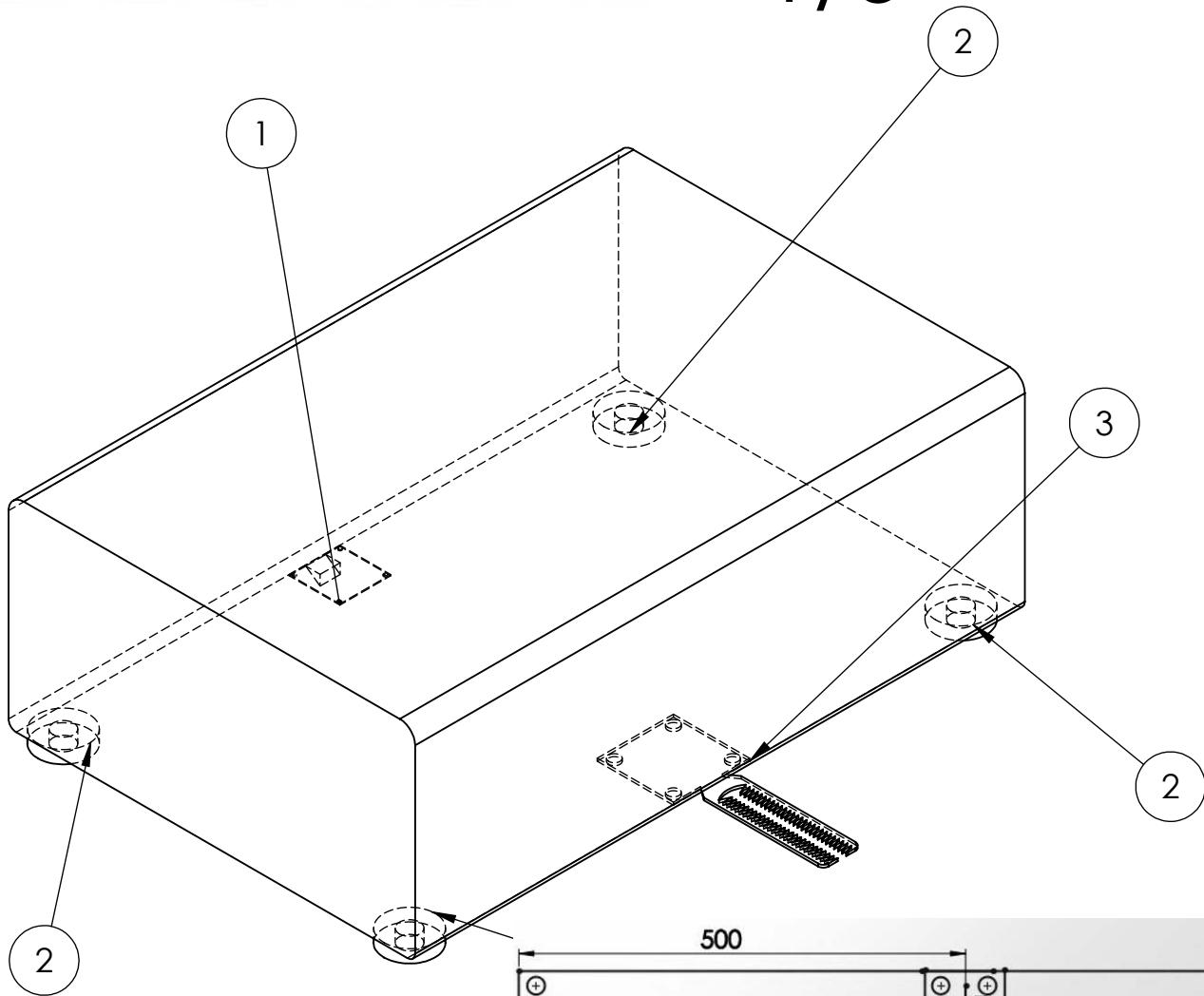

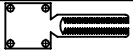
30 min.

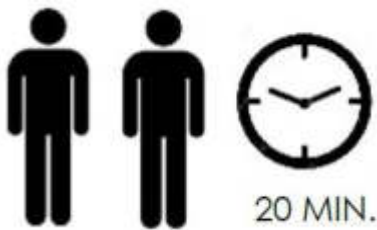
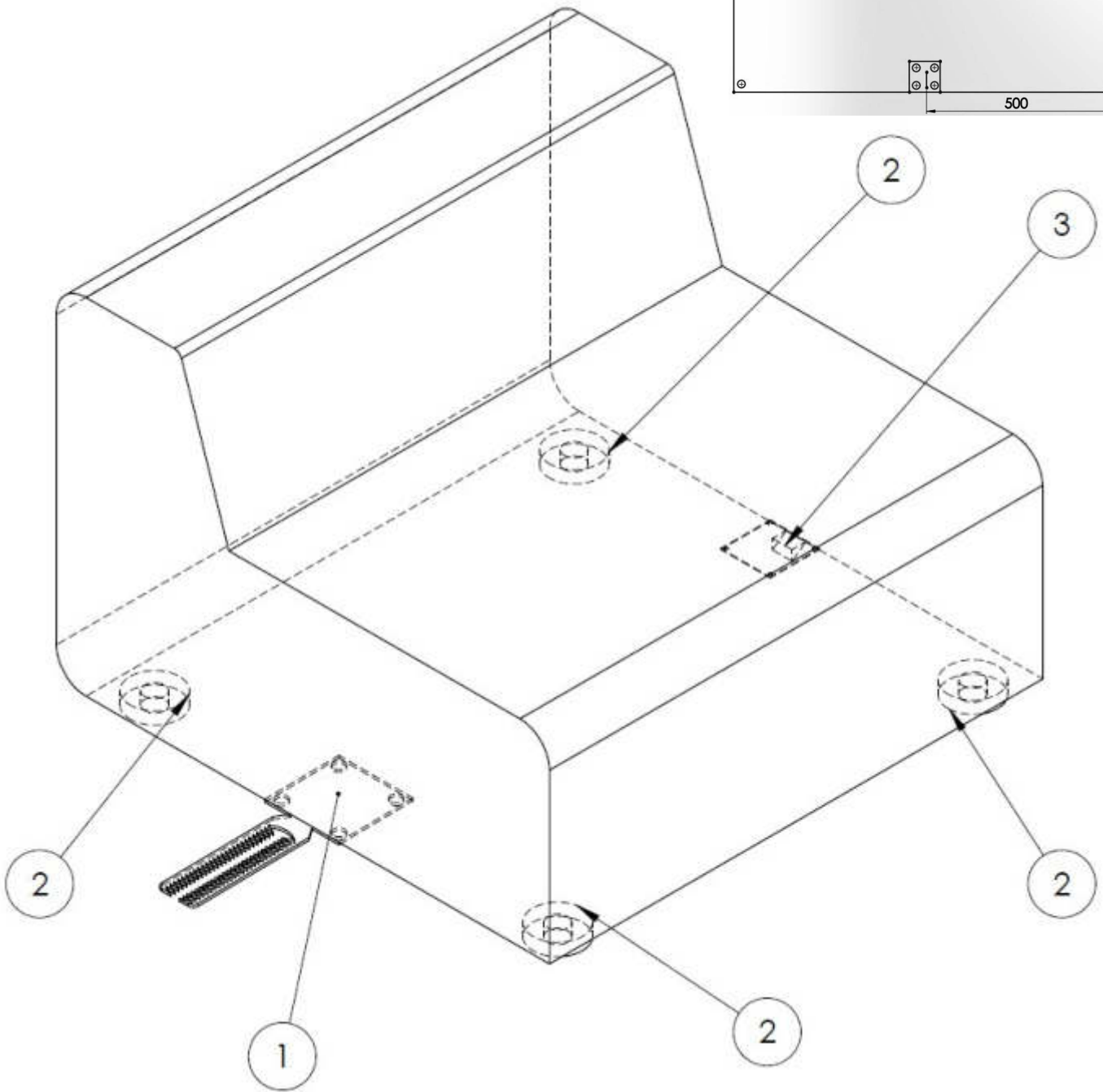
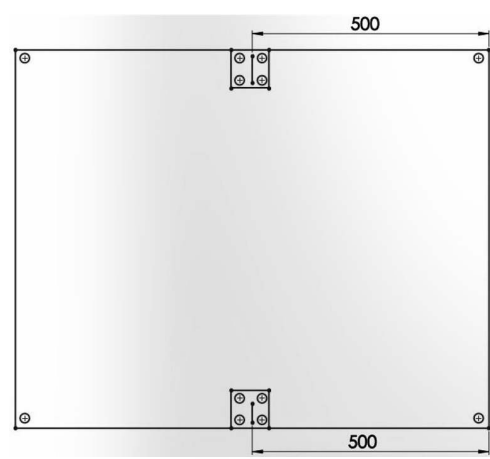

ITEM No.	ITEM	QUANTITY
1.		1
2.		4
3.		1